

DANESE

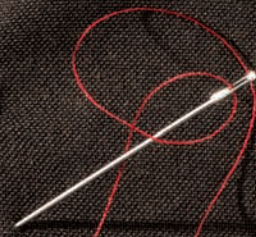

MILANO



DANESE



MILANO

La collezione Danese 2019 e il lavoro con cui è stata pensata possono essere riassunti dalla parola RICUCITURE, ovvero una serie di operazioni progettuali in grado di relazionarsi con il passato ed il presente di Danese.

Delicate operazioni di ricucitura per far emergere amicizie, vicinanze ed empatie tra prodotti esistenti e di nuova formazione, indagando anche aree mai esplorate prima da Danese (vedi l'accessorio per la persona) ed alimentando anche il filone della ricerca materica e funzionale, un aspetto sempre presente nelle collezioni Danese precedenti. L'idea è di muoversi quindi in più direzioni per ribadire lo spirito libero e trasversale di Danese.

Ho pensato di utilizzare un disegno per raccontare al meglio la nuova collezione, il lavoro si è mosso secondo tre azioni progettuali: RELAZIONI, RIEDIZIONI, RICERCA. Lo schema ad insiemistici qui riportato dovrebbe aiutare ad orientarsi meglio tra gli elementi della nuova collezione.

The Danese 2019 collection and the work invested in it can be summarised by the word RICUCITURE (RESTITCHING), a series of design operations which relate to Danese both past and present.

Delicate restitching operations to bring out friendship, closeness and empathy between existing products and new creations, investigating areas never explored before by Danese (see the accessory for the person) and also feeding the material and functional research always present in previous Danese collections. The idea is to move in several directions to reaffirm the free and transversal spirit of Danese.

I thought of using a drawing to better explain the new collection, the work moved according to three design actions: RELAZIONI, RIEDIZIONI, RICERCA (RELATIONS, RE-RELEASES, RESEARCH). The set theory diagram shown here should help you to better orient yourself between the elements of the new collection.

Giulio Iacchetti

- 1 Cone**_Giulio Iacchetti, 2019
- 2 Sula**_Giulio Iacchetti, 2019
- 3 Cicladi**_Enzo Mari, 1977
- 4 IPE**_Giulio Iacchetti, 2019
- 5 Matua**_Giulio Iacchetti, 2019
- 6 Kurili**_Enzo Mari, 1973
- 7 Giglio**_Enzo Mari, 1985
- 8 Alphabet**_BIG, 2019
- 9 Sponge Lamp**_BIG, 2019
- 10 Quaderni Moleskine**, 2019
- 11 Madera**_Enzo Mari, 1973
- 12 Lingotto**_Giulio Iacchetti, 2006
- 13 TAU**_Giulio Iacchetti, 2019

* **Cone and Sula**
are dreaming of **Elisabetta tray**

* **IPE and TAU**
have dreamed of **Putrella**

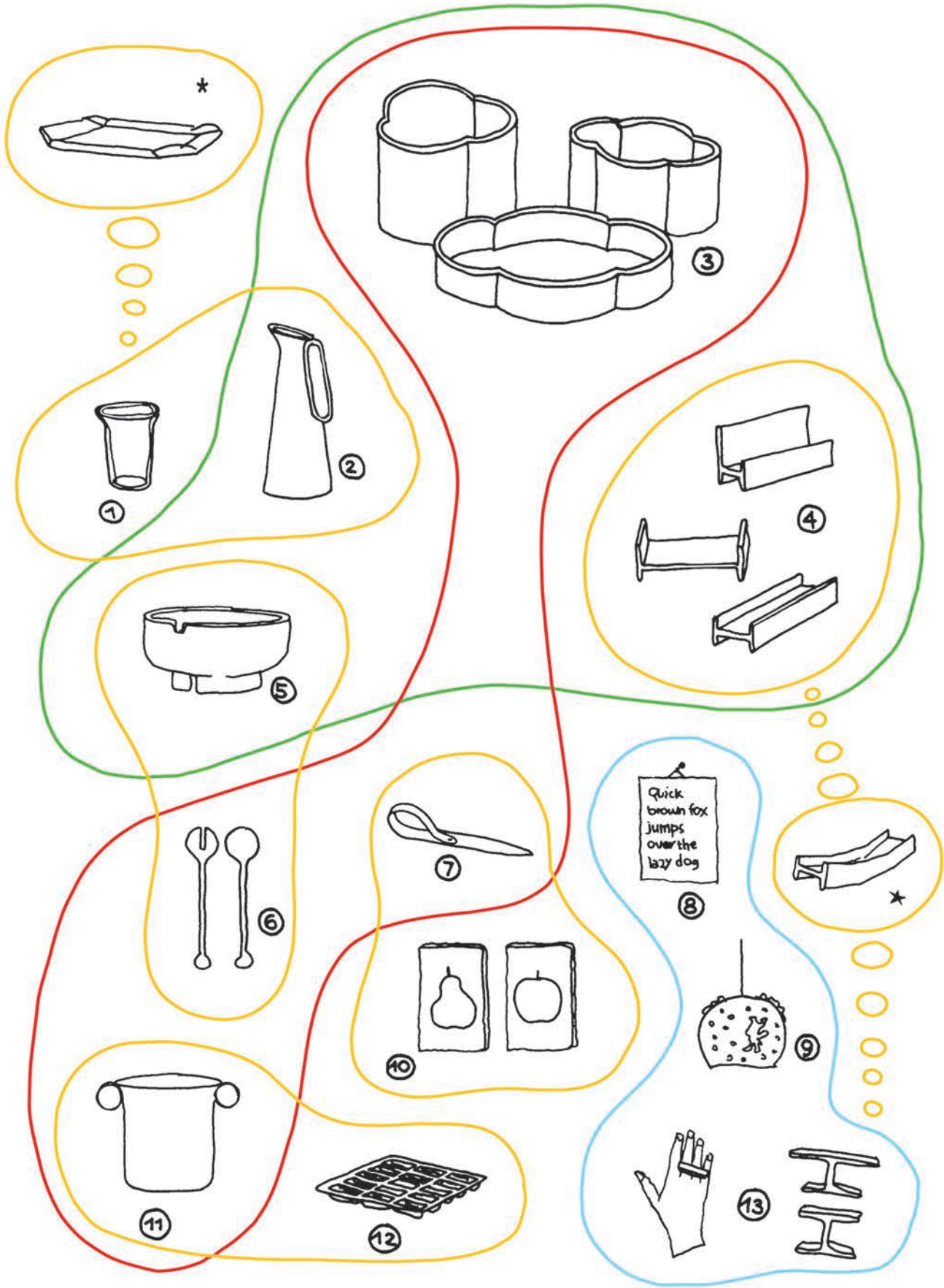



SULA_GIULIO IACCHETTI, 2019

Caraffa in ceramica_ceramic pitcher

La caraffa Sula suggerisce l'utilizzo dell'acqua del rubinetto a tavola o in ufficio, in linea con i valori di sostenibilità ambientale. La bocca larga consente l'inserimento di cubetti di ghiaccio, foglie di menta o fette di limone per aromatizzare l'acqua. La ceramica, con cui è costituita, è un materiale ideale per il mantenimento termico del liquido contenuto.

The Sula pitcher is perfect for serving tap water at the table or in the office, in line with the values of environmental sustainability. The wide mouth allows the insertion of ice cubes, mint leaves or lemon slices to flavour your water, while ceramic is the ideal material to maintain the temperature of the liquid inside.

MATERIALE • MATERIAL

ceramica • ceramic

bianca • white
nera • black

DGI2712A10
DGI2712A09

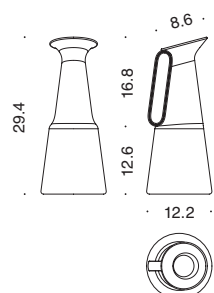



CONE_GIULIO IACCHETTI, 2019

Bicchiere in vetro *glass tumbler*

La morbidezza della bocca del bicchiere rimanda alle forme della brocca Sula di cui è il naturale completamento. Il disegno svasato ne permette l'impilabilità. La finitura sabbata trasmette un senso di freschezza e refrigerio.

The soft mouth of the glass evokes the shapes of the Sula pitcher of which it is the natural companion. The flared design allows for stacking, and the sandblasted finish conveys a sense of cool freshness.



MATERIALE • MATERIAL

vetro borosilicato trasparente finitura sabbata • *transparent borosilicate glass, sanded finish*

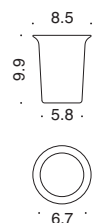

DGI2708A00







TAU_GIULIO IACCHETTI, 2019

Gioiello infradito_finger jewel

Tau è un gioiello infradito. Si posiziona tra le dita della mano, facilissimo da sfilare, ridisegna totalmente il rapporto tra le dita e l'accessorio che le decora. In sole cinque misure (tre dedicate alla donna e due all'uomo) si declina in due forme e tre materiali: argento lucido, ottone satinato e titanio (solo per i TAU uomo).

Tau is a finger jewel. Positioned between the fingers, and very easy to remove, Tau totally redesigns the relationship between the fingers and the accessory that decorates them. Available in just five sizes (three for women and two for men) it comes in two shapes and three materials: polished silver, satin brass and titanium (men's TAUs only).

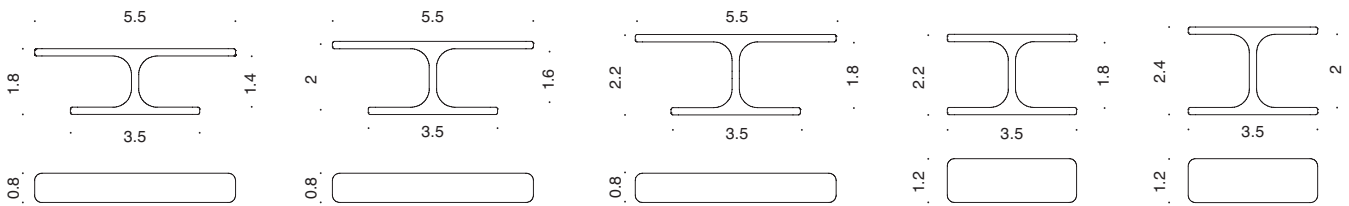

MATERIALI • MATERIALS

argento, ottone, titanio • silver, brass, titanium

gioiello donna argento taglia S • female silver S size jewel
gioiello donna argento taglia M • female silver M size jewel
gioiello donna argento taglia L • female silver L size jewel
gioiello donna ottone taglia S • female brass S size jewel
gioiello donna ottone taglia M • female brass M size jewel
gioiello donna ottone taglia L • female brass L size jewel
gioiello uomo titanio taglia L • male titanium L size jewel
gioiello uomo titanio taglia XL • male titanium XL size jewel

DGI2706AAG
DGI2706BAG
DGI2706CAG
DGI2706AOT
DGI2706BOT
DGI2706COT
DGI2707ATI
DGI2707BTI



IPE_GIULIO IACCHETTI, 2019

Organizzatori scrivania *desk organizers*

Il set è composto da tre elementi: portamatite, portaogetti e portabuste. Il disegno della loro sezione, derivata dalla trave tipo Ipe, consente a questi elementi di assumere posizioni diverse sul piano, divenendo di volta in volta porta foto, porta telefono o piani d'appoggio per piccoli oggetti...

The set consists of three elements: pencil holder, object holder and envelope holder. Their section design, derived from the Ipe-type beam, allows these elements to assume different positions on the desk surface, becoming a photo holder, telephone holder or supporting surface for small objects as necessary...

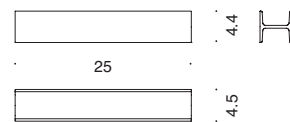
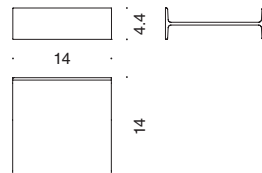
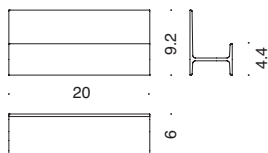

MATERIALE • MATERIAL

ceramica • *ceramic*

portapenne • *pen holder*

portacarta • *paper holder*

organizzatore scrivania • *desk organizer*

DGI2709A10

DGI2709B10

DGI2709C10

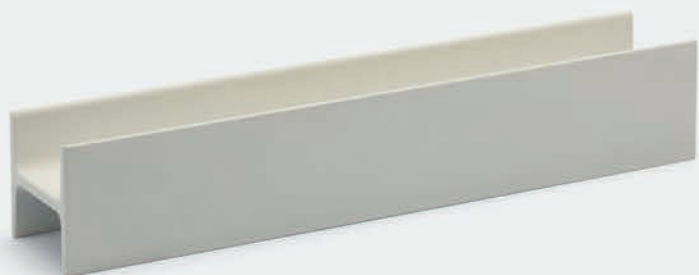
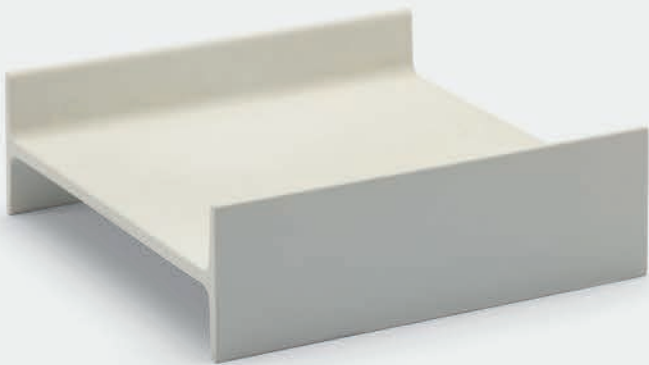
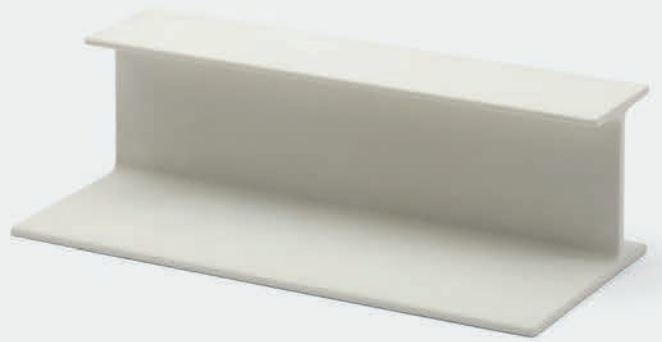





MATUA_GIULIO IACCHETTI, 2019

Ciotola in ceramica *ceramic bowl*

Avvicinata alle posate KURILI completa il set da insalata. Un piccolo scasso sul bordo superiore ospita le posate evitando loro di cadere verso l'interno, un altro intaglio sull'anello d'appoggio evita l'accumulo di acqua quando la ciotola viene posta in lavastoviglie. Matua può essere utilizzata singolarmente anche come centro tavola o svuota tasche.

Alongside the KURILI cutlery, it completes the salad set. A small notch in the upper edge houses the cutlery, preventing it from falling inwards, while another notch on the support ring prevents water from accumulating when the bowl is placed in the dishwasher. Matua can also be used on its own as a table centre or change tray.



MATERIALE • MATERIAL

ceramica • *ceramic*

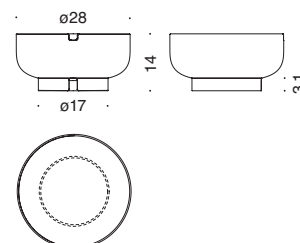

DGI2711A10

KURILI_ENZO MARI, 1973 / re-edition 2019

Posate insalata_ *salad servers*

Due posate da insalata, cucchiaio e forchetta, in acciaio inossidabile lucido. Hanno la stessa geometria pura in cui un taglio cambia la funzione.

A salad spoon and fork made of polished stainless steel. They feature the same pure geometry, with an incision changing the function.



MATERIALE • MATERIAL

acciaio inossidabile lucidato • *polished stainless steel*

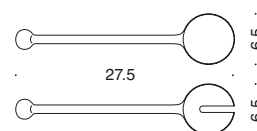

set 2 posate • *2 cutlery set*

DE3105B00





MADERA_ENZO MARI, 1973 / re-edition 2019

Secchiello_bucket

È un secchiello in ottone placcato argento per tenere in fresco il vino o per macedonia, punch, ecc ...

A silver plated brass bucket to keep wine cool or to serve fruit salad, punch, etc...



MATERIALE • MATERIAL

ottone placcato argento • *silver plated brass*

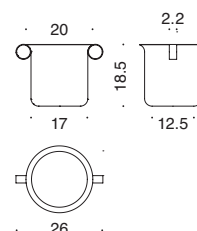

DE3102B00

LINGOTTO_GIULIO IACCHETTI, 2006 / re-edition 2019

Formaghiaccio_ice cube tray

Come trasmettere il concetto che l'acqua è preziosa come l'oro?
Forse ripensando all'estetica dei cubetti di ghiaccio, che da cubici
assumono la forma dell'archetipico lingotto d'oro tronco-piramidale.

*How to convey the concept that water is as precious as gold?
Perhaps by rethinking the aesthetics of ice cubes, which take the
form of an archetypal gold ingot.*



MATERIALE • MATERIAL

gomma siliconica • *silicon rubber*

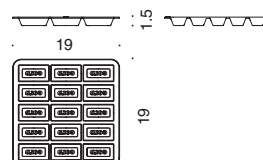

DGI2710A14

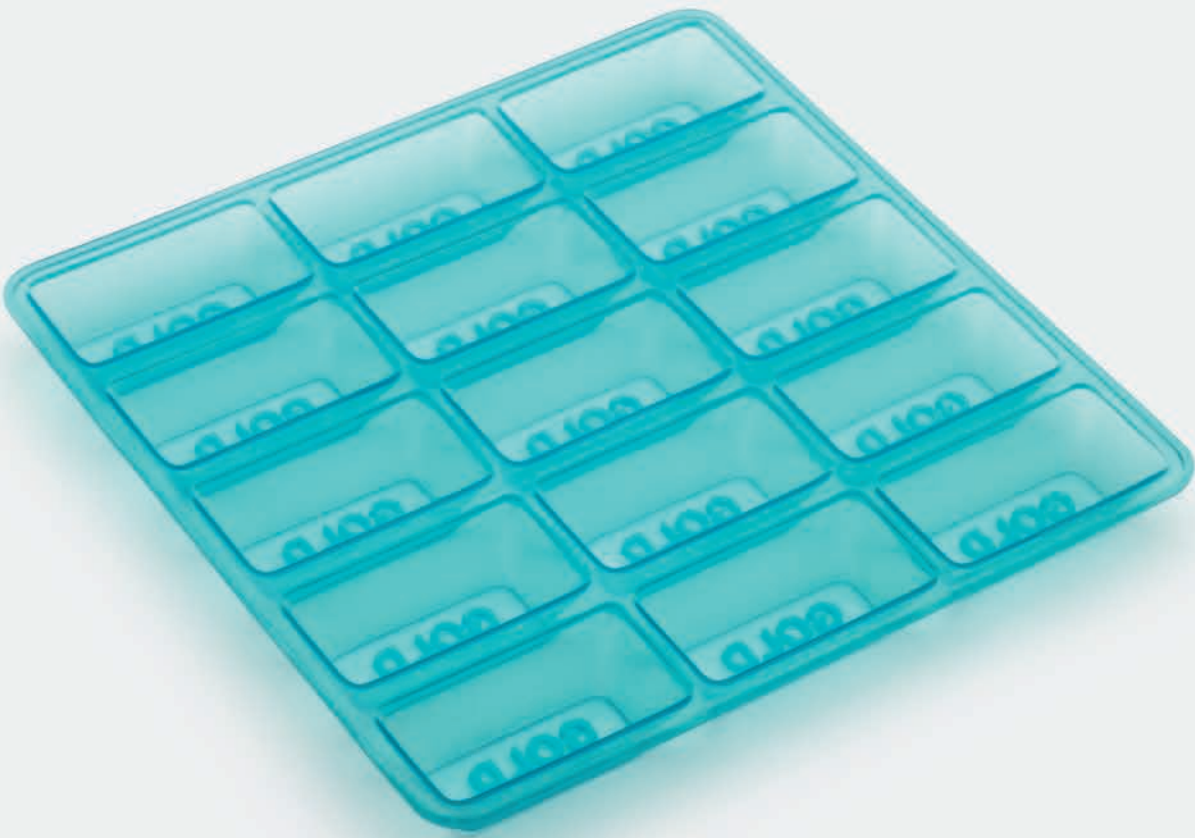



CICLADI_ENZO MARI, 1977 / re-edition 2019

Contenitori e fioriere *containers and flower-pot stands*

È una famiglia di tre contenitori in ceramica riferiti alla morfologia vegetale che prosegue la ricerca formale e materica dei vasi per fiori Bambù e Trifoglio. Rosa antico, bianco e sabbia sono i toni naturali che evidenziano la grana materica della ceramica.

A family of three ceramic containers that resemble the form of plants, continuing the formal and material research of the Bambù and Trifoglio flower vases. The natural colours that highlight the texture of the ceramic are old rose, white and sand.

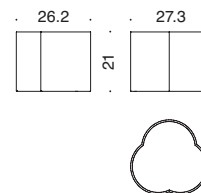
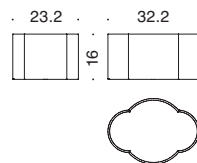
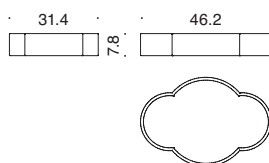

MATERIALE • MATERIAL

ceramica • ceramic

h 78 mm rosa antico • h 78 antique pink

h 160 mm bianco • h 160 white

h 210 mm sabbia • h 210 sand

DE3113A20

DE3113B10

DE3113C55

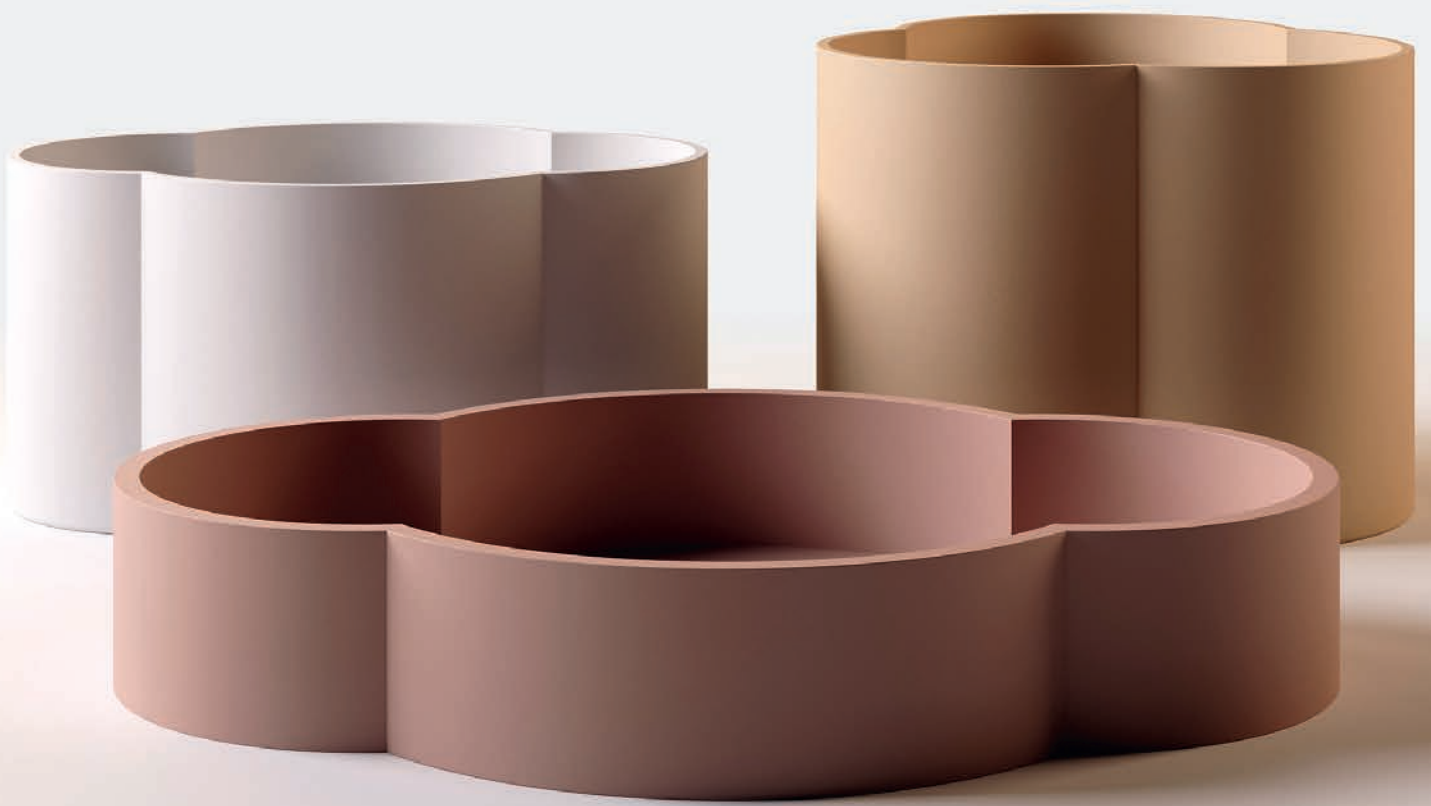









GIGLIO_ENZO MARI, 1985 / re-edition 2019

Tagliacarte_ *letter opener*

Giglio continua la ricerca di Benbecula e Ameland, la "produzione sperimentale" di Enzo Mari sui tagliacarte realizzati con operazioni elementari di taglio e piegatura.

È una rielaborazione che rivede il profilo sagomato in modo da evitare qualsiasi spigolo. Il nastro si richiude su sé stesso così da formare un manico vero e proprio che lo rende più maneggevole ma anche più simile a uno strumento tradizionale.

Giglio continues the research of Benbecula and Ameland, Enzo Mari's "experimental production" on letter openers, created with basic cutting and folding operations.

A process which takes a new look at the shaped profile, eliminating every sharp edge. The tape bends back onto itself to form a handle which makes it easy to use and more similar to a traditional letter opener.

MATERIALE • MATERIAL

acciaio armonico lucidato • *polished harmonic steel*

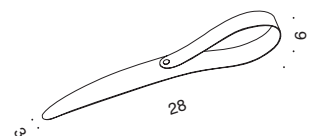

DE3127B00



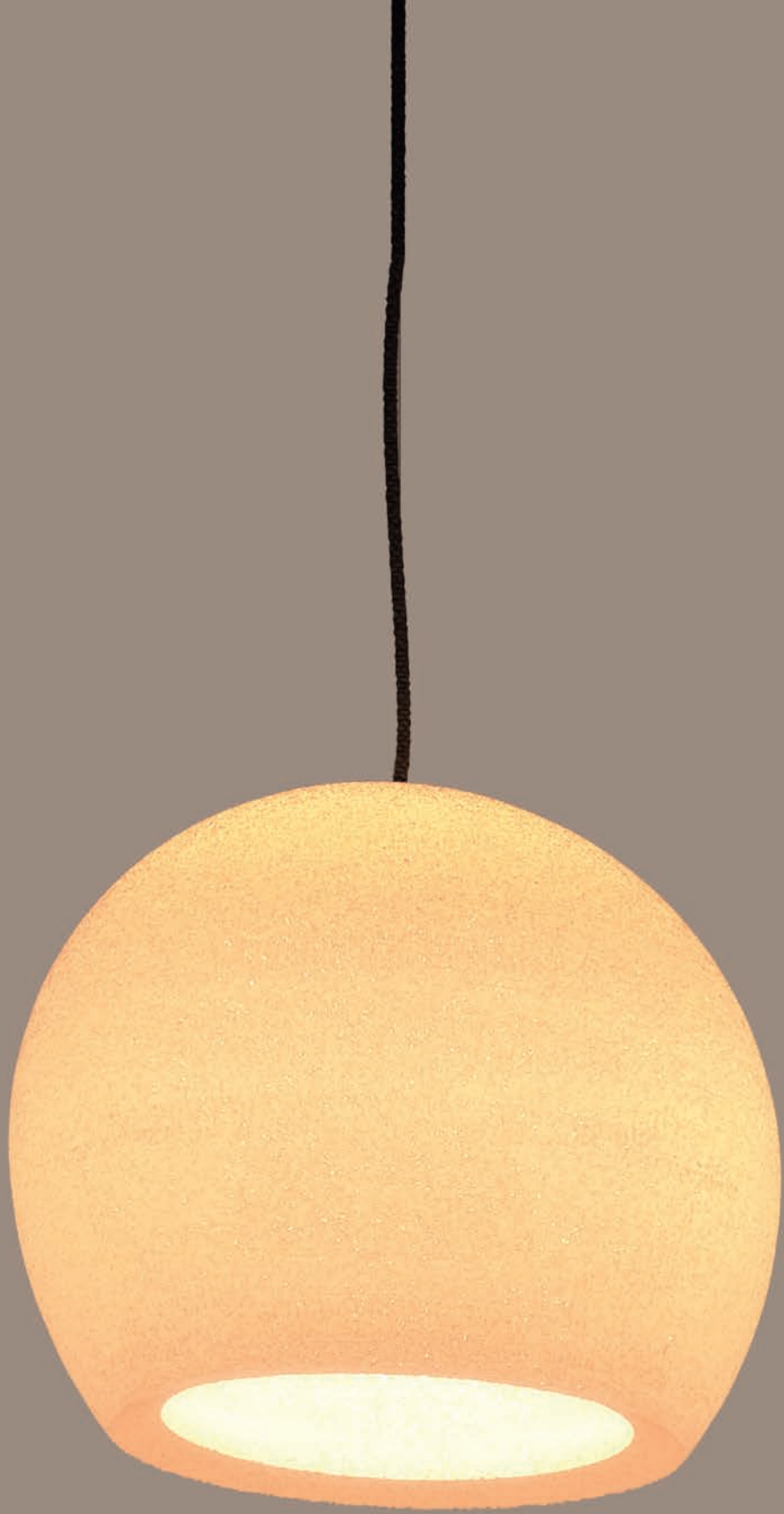



SPONGE LAMP_BIG, 2019

Lampada in spugna_sponge lamp

Un inedito diffusore in spugna accoglie luce e natura: è un elemento che può vivere in diverse posizioni, sospeso, appeso con una corda o appoggiato a pavimento. Il materiale poroso della spugna si anima di luce e offre supporto ideale per la crescita di muschio o di piccole piante. Perfetto per integrarsi in un giardino o in un terrazzo fiorito ma anche per portare la natura in interni.

This original sponge diffuser welcomes light and nature and is an element that can occupy various positions, suspended, hung from a rope or placed on the floor. The porous material of the sponge comes to life with light and offers the perfect base for the growth of moss or small plants. Perfect in any garden or on a terrace decorated with plants, but also the ideal way to bring nature indoors.



MATERIALE • MATERIAL

poliuretano a cellula regolare 20PPI • open regular cell polyurethane foam 20PPI

sospensione • suspension
gancio • hook

DBI6430A00
DBI6430B00

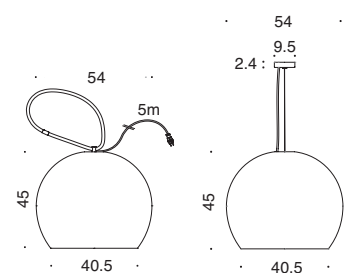



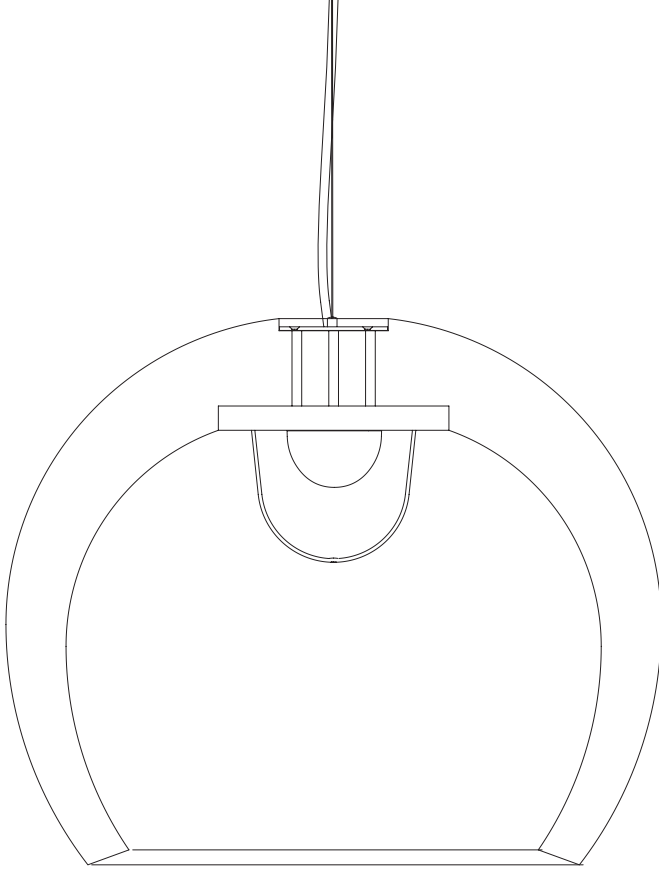

IP65

Total Power: 20W

815lm

CRI=80

Energy Label: A++ → A

Il corpo in spugna grazie alla sua porosità può trattenere acqua e nutrienti necessari alla crescita di piccoli vegetali. La sorgente luminosa interna ha protezione IP65; non crea quindi nessun problema l'utilizzo di acqua sul diffusore.

The sponge structure is able to host, thanks to its porosity, water and nutrients needed for the growth of small plants.

The luminous internal sphere is IP65 and therefore protected from the water usage on the diffuser.

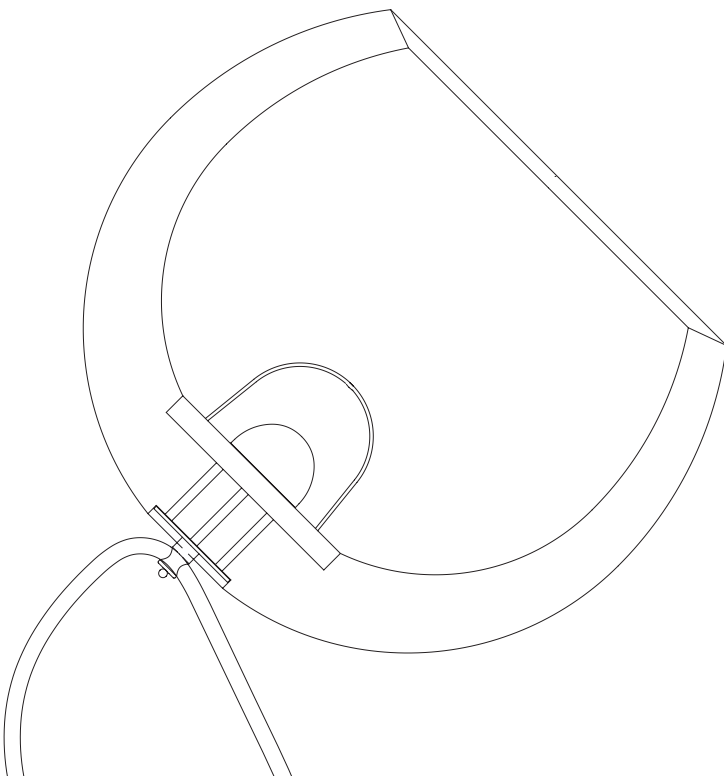
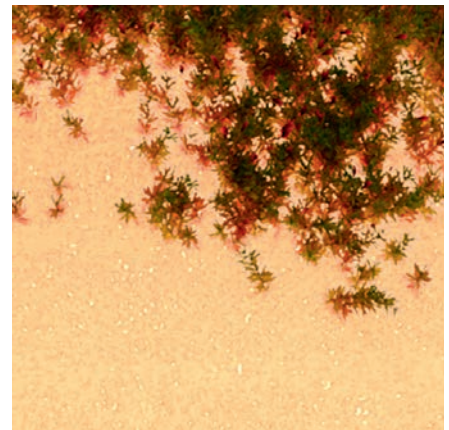



THE ALPHABET_BIG, 2019

stampa serigrafica - *silkscreen art*

"The alphabet" è un pangramma che riflette sul linguaggio, tutte le lettere dell'alfabeto compongono un messaggio con il font di luce disegnato da BIG che diventa una grafica educativa.

Un progetto perfettamente coerente con la storia Danese delle iconiche grafiche di Enzo Mari e dei giochi didattici di Bruno Munari.

"The alphabet" is a pangram which reflects on language. All the letters of the alphabet make up a message with the light source designed by BIG, becoming an educational work.

A project which is perfectly in line with Danese's history of Enzo Mari's graphic icons and Bruno Munari's educational toys.



MATERIALE • MATERIAL

carta fatta a mano Hahnemuhle 300g/mq • *hand-made paper Hahnemuhle 300g/m²*

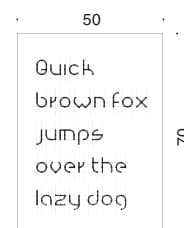

DBI6420A00

Quick

brown fox

jumps

over the

lazy dog

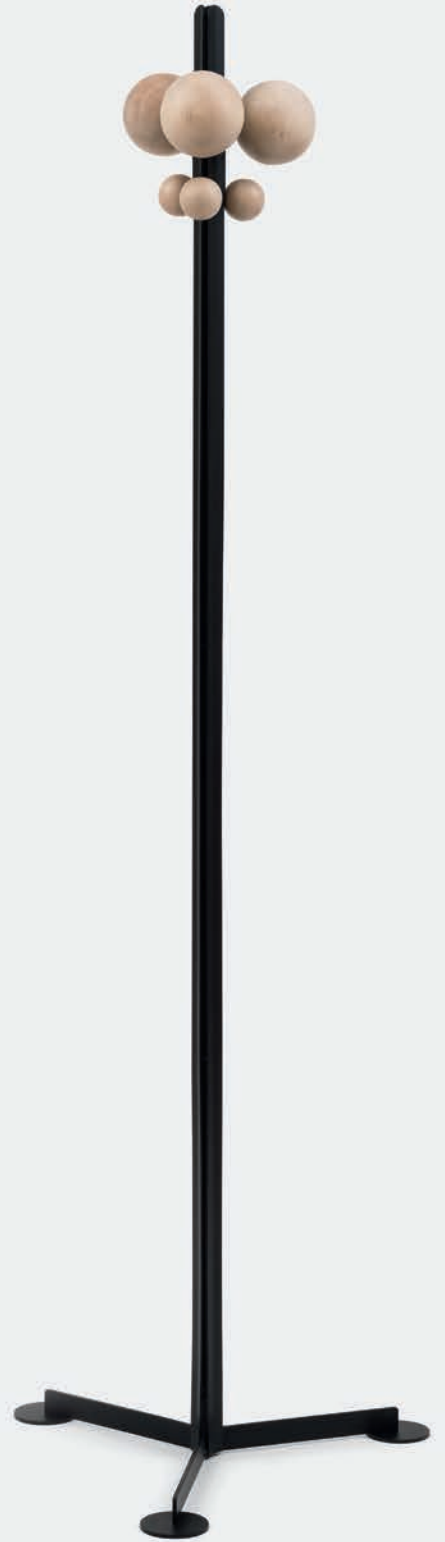
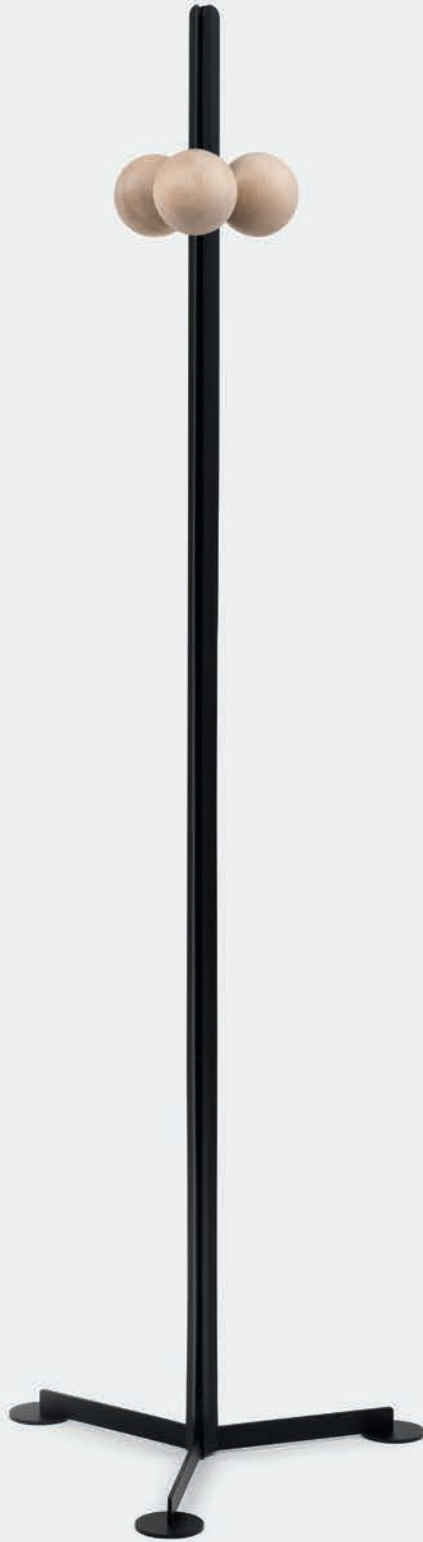
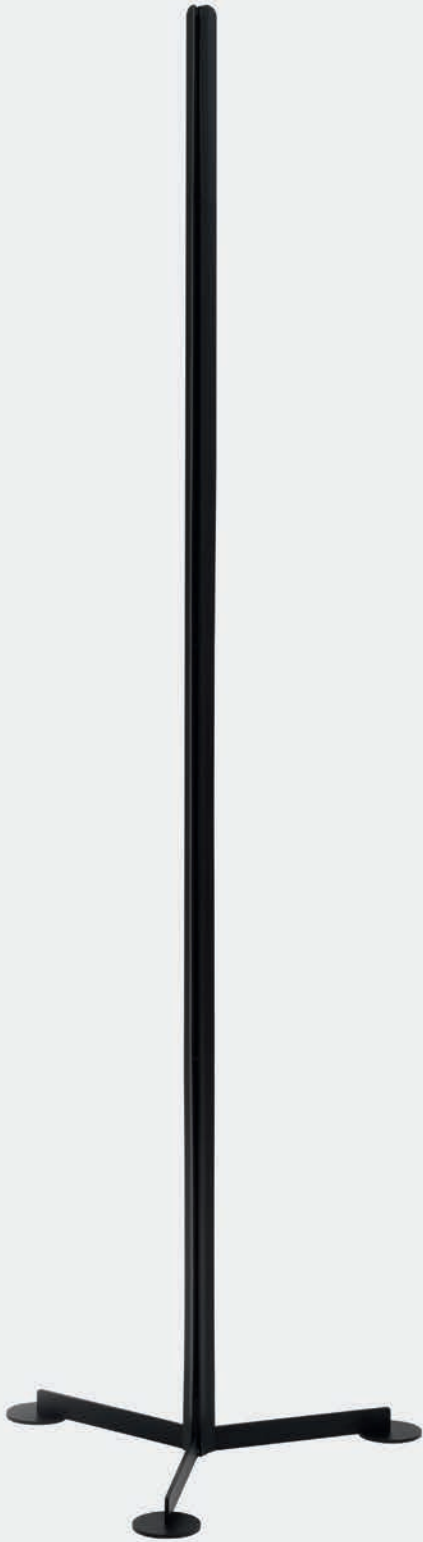

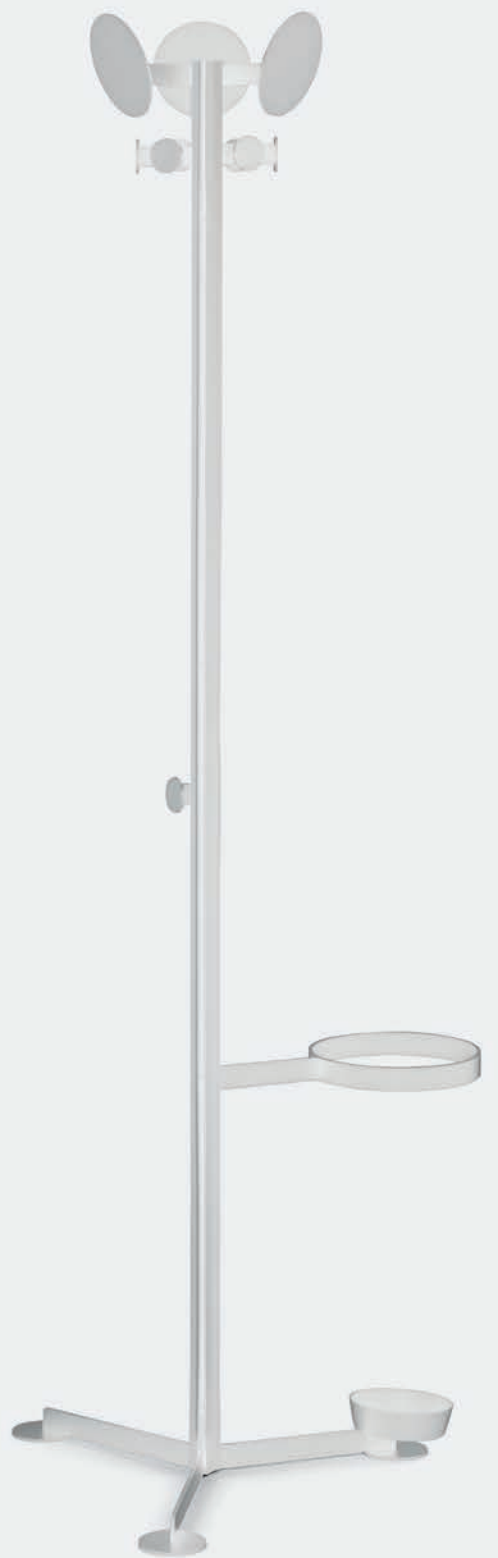





FAMILIA_RICHARD HUTTEN, 2018

Appendiabiti, sistema di transenne, tavoli, portaombrelli - *coat hanger, barrier system, tables, umbrella stand*

Un sistema dinamico che a partire da una sezione intelligente cresce con le esigenze di chi lo utilizza. Appendiabiti, tavoli, portaombrelli, transenne che si compongono a diverse altezze e in infinite combinazioni.

A dynamic system that begins with a smart section and grows with the needs of the user. Coat stands, tables, umbrella stands and barriers which can be used together to create different heights and in an endless variety of combinations.

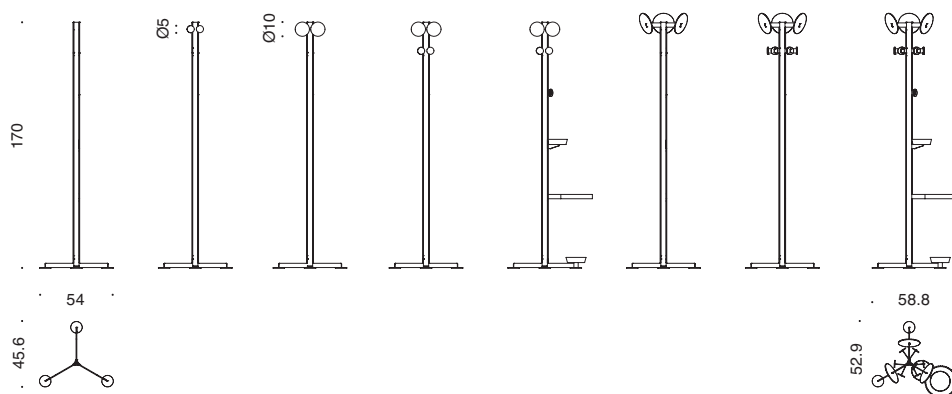

MATERIALI • MATERIALS

metallo verniciato a polvere, sfere in legno massello, corda in nylon • *powder coated metal, solid wood spheres, nylon cord*

struttura appendiabiti + base, nero • <i>coat hanger structure + base, black</i>	DRH0045A09
struttura appendiabiti + base, bianco • <i>white coat hanger structure + base, white</i>	DRH0045A10
set ganci grandi (3x), nero • <i>big hook set (3x), black</i>	DRH0045B09
set ganci grandi (3x), bianco • <i>big hook set (3x), white</i>	DRH0045B10
set ganci piccoli (3x), nero • <i>small hook set (3x), black</i>	DRH0045C09
set ganci piccoli (3x), bianco • <i>small hook set (3x), white</i>	DRH0045C10
set sfere grandi (3x) • <i>big spheres set (3x)</i>	DRH0045B0L
set sfere piccole (3x) • <i>small spheres set (3x)</i>	DRH0045C0L
accessorio svuotatasche, nero • <i>pocket-emptier accessory, black</i>	DRH0045D09
accessorio svuotatasche, bianco • <i>pocket-emptier accessory, white</i>	DRH0045D10
accessorio portaombrelli, nero • <i>umbrella holder accessory, black</i>	DRH0045E09
accessorio portaombrelli, bianco • <i>umbrella holder accessory, white</i>	DRH0045E10
accessorio porta-borse, nero • <i>hang bags accessory, black</i>	DRH0045F09
accessorio porta-borse, bianco • <i>hang bags accessory, white</i>	DRH0045F10
sfera parete • <i>sphere wall hanger</i>	DRH0046A0L
tavolo h 100 singolo, nero • <i>single h 100 table, black</i>	DRH0045I09
tavolo h 100 singolo, bianco • <i>single h 100 table, white</i>	DRH0045I10
tavolo h 70 singolo, nero • <i>single h 70 table, black</i>	DRH0045M09
tavolo h 70 singolo, bianco • <i>single h 70 table, white</i>	DRH0045M10
tavolo h 100 triplo, nero • <i>triple h 100 table, black</i>	DRH0045L09
tavolo h 100 triplo, bianco • <i>triple h 100 table, white</i>	DRH0045L10
tavolo h 70 triplo, nero • <i>triple h 70 table, black</i>	DRH0045N09
tavolo h 70 triplo, bianco • <i>triple h 70 table, white</i>	DRH0045N10
struttura transenna (1x), nero • <i>barrier structure (1x), black</i>	DRH0045G09
struttura transenna (1x), bianco • <i>barrier structure (1x), white</i>	DRH0045G10
corda blu • <i>blue cord</i>	DRH0045H14
corda rossa • <i>red cord</i>	DRH0045H16







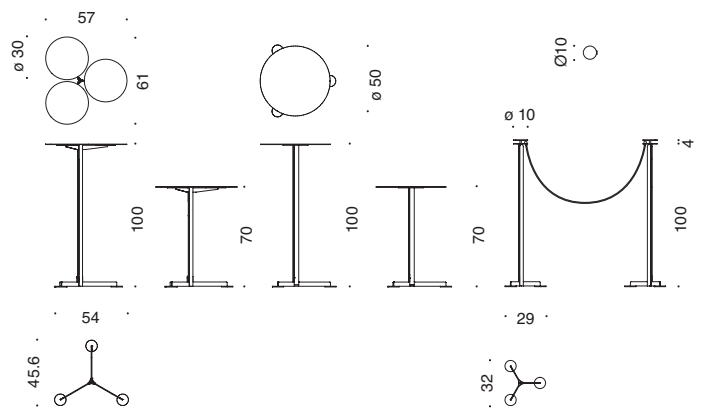







TRESPOLONE, TRESPOLINO, TRESPOLETTO_MICHELE DE LUCCHI, 2018

Appendiabiti, tavoli regolabili, portaombrelli - *coat hanger, adjustable tables, umbrella stand*

La struttura in legno ispirata a un cavalletto da pittore a tre gambe sostiene un piano, rettangolare o tondo, o il corpo appendiabiti con sei ganci e un portaombrelli. Cinque diverse altezze per offrire funzionalità e libertà di utilizzo: un tavolo dove appoggiare un laptop, un piedistallo, un piano di servizio.

The wooden structure inspired by an artist's tripod supports a top, which can be either rectangular or round, or the body of the coat stand with six hooks and an umbrella stand. Five different heights to offer practicality and freedom of use: a laptop rest, a pedestal or a serving table.

MATERIALI • MATERIALS

legno di faggio, metallo verniciato a polvere • *beech wood, powder coated metal*

Trespalone	DDL0033A0L
struttura treppiede + appendiabiti • <i>tripod structure + coat hanger</i>	
accessorio portaombrelli • <i>umbrella stand accessory</i>	DDL0033D00
Trespolino	DDL0033B0L
struttura treppiede + piano rotondo • <i>tripod structure + round top table</i>	
Trespoletto	DDL0033C0L
struttura treppiede + piano rettangolare • <i>tripod structure + rectangular top table</i>	

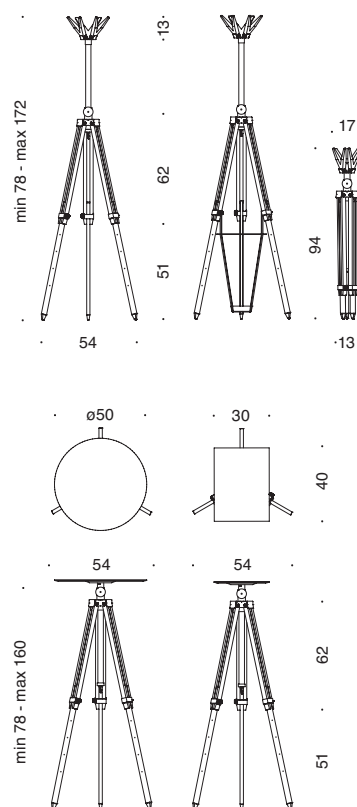







Stanze di vita quotidiana
Photo by Francesca Ferrari

















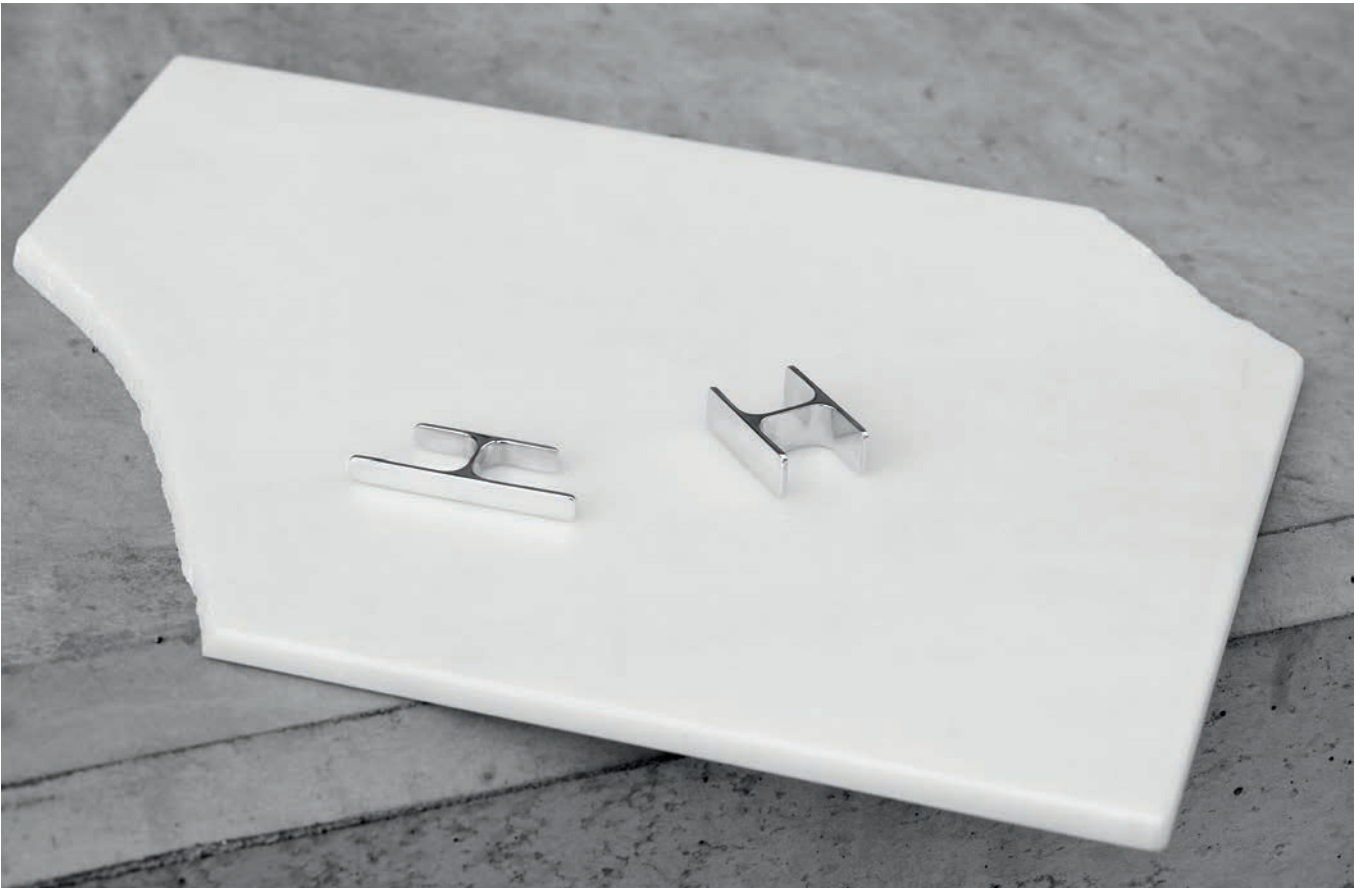



Collezione 2019 a cura di • 2019 Collection edited by: Giulio Iacchetti
Testi: Giulio Iacchetti, Laura Salviati
Progetto grafico • Graphics and layout: Diego Martinelli, Sara Riva
Foto • Photos: Federico Villa
Foto stanze di vita quotidiana • Stanze di vita quotidiana photos: Francesca Ferrari

Ringraziamenti • Thanks to:
Francesco Bariani, Stefano Lodola,
Giona Andreani, Alessandro Peccati,
Francesco Bena, Valeria Sposato
Mario Scairato, Gaia Anselmi Tamburini,
Lidia Spina, Luca Madonini, Davide (Marco) Biancucci

DANESE

MILANO

DANESE
Via Canova 34
20145 Milano (MI) Italy
T. +39.02.349611
info@danese milano.com
www.danese milano.com

SHOWROOM
Piazza San Nazaro in Brolo 15
20122 Milano (MI) Italy
T. +39.02.58304150
showroomdanese@artemide.com

Artemide
Artemide S.p.A.
Corso Monforte, 19
20122 Milano (MI) Italia
www.artemide.com

